

PHOTO VIDEO DRONE

CATALOG 2025



NANUK[™]

Protect | Organize | Mobilize





NANUK™

Like the creatives we design for, we're passionate professionals who obsess over every detail. What drives us is simple: to always find a better way to protect, organize, and mobilize your photo, video, and drone gear—so you can focus on capturing the perfect shot.

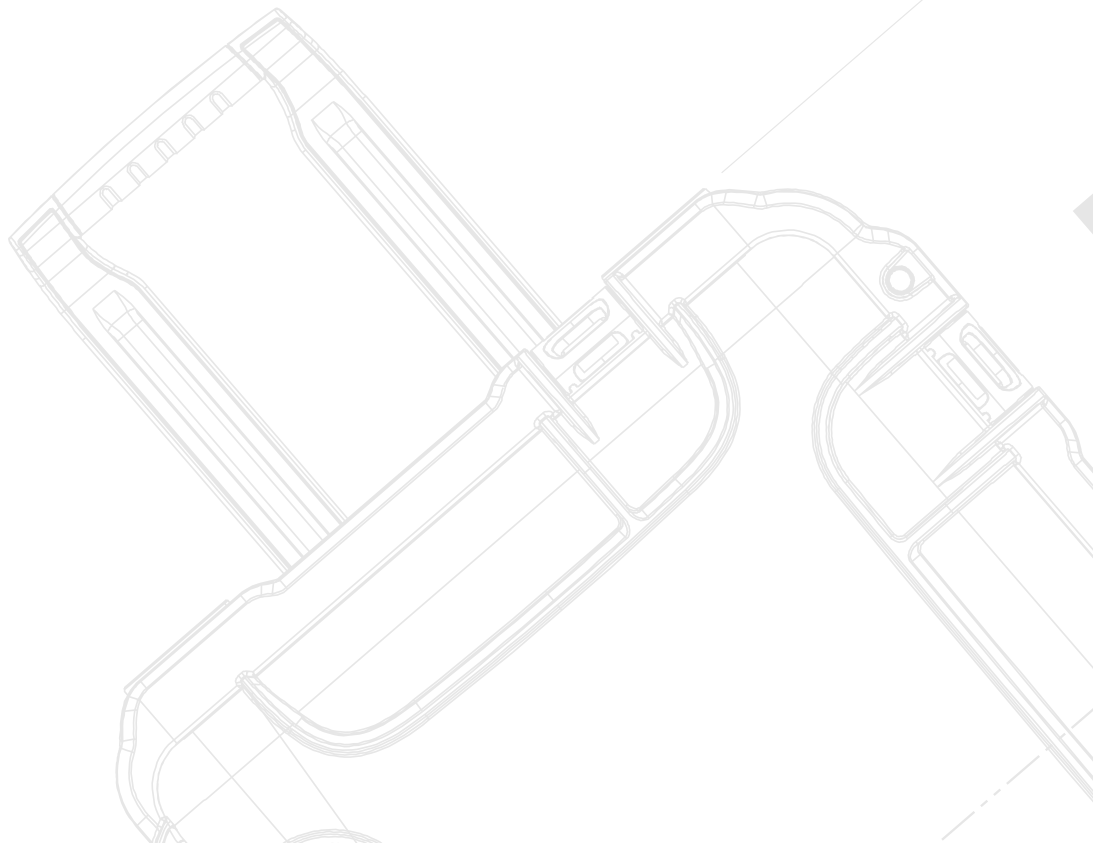

SUMMARY

WHY CHOOSE NANUK	7
INTRODUCING A BACKPACK LINE	18
CUSTOMISABLE GEAR PROTECTION	29
COLLECTION FOAM - DRONE	41
COLLECTION FOAM - PHOTO/VIDEO	47
ECO-FRIENDLY COLLECTION	51
LINE REFERENCE	55





NANUK



NANUK

NANUK

NANUK

NANUK

NANUK



WHY CHOOSE NANUK

NANUK Advantage

NANUK FEATURES

NANUK protective cases are the result of years of testing both in the lab and on the field and offer unrivaled protection in a variety of sizes, configurations and colors, with its patented PowerClaw latching system and NK-7 resin outer shell, NANUK is built for nature's most unforgiving conditions.

Rugged, waterproof and guaranteed for life, all NANUK cases are designed to withstand the smallest tumbles to the biggest shocks and everything in between. When it needs to get there in one piece, it needs to go in a NANUK.

SUPERIOR DESIGN



IP67 DUSTPROOF WATERPROOF



INDESTRUCTIBLE NK-7 RESIN



POWERCLAW SUPERIOR LATCHING SYSTEM



REINFORCED METAL PADLOCK HOLES



STAINLESS STEEL HARDWARE



AUTOMATIC PRESSURE RELEASE VALVE







POLYURETHANE WHEELS



SOFT GRIP HANDLE



NANUK Certifications

Icons	Certifications	Tests
	DEF-STAN 81-41 STANAG 4280	Dry Heat Low Temp Vibration Water Spray-Rain Impact-Drop
	MIL-STD-810H	High Temp Low Temp Water Spray-Rain Immersion Vibration Transit Drop Fungus
	IP67	Dustproof Waterproof
	Specifications ATA 300	Category 1 Impact Test

Tested by an independent laboratory in accordance with the following standards



**LIFETIME
WARRANTY**



**CRUSHPROOF
RESIN**



**MILITARY
APPROVED**



**MADE IN
CANADA**

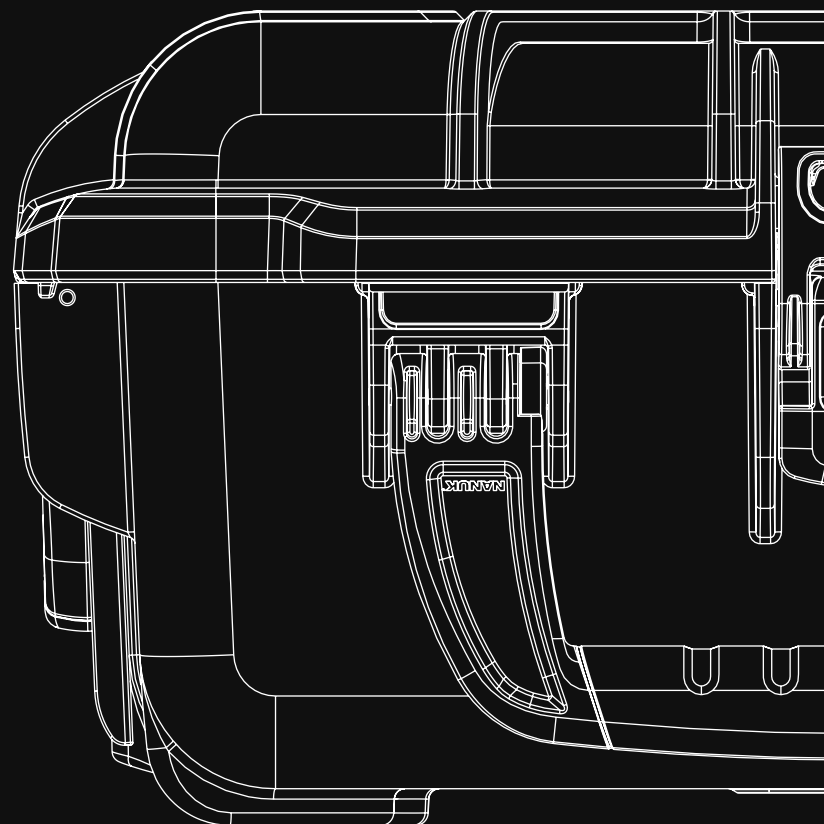

**Together, Let's Reduce
our Carbon Footprint,
One Case at a Time.**





Eco-Friendly Collection

THE FUTURE IS HERE

At NANUK, we're thrilled to introduce our latest innovation: the **NANUK-R Collection—the only eco-friendly, high-end protective cases that reduce carbon footprints by over 50%**. We believe quality and sustainability go hand in hand. While maintaining the same durability and functionality, our NANUK-R cases use eco-friendly materials, reducing reliance on virgin resins and diverting waste from landfills.

Our commitment to protection remains unwavering—each case undergoes rigorous quality control to ensure top-tier performance. By choosing eco-friendly NANUK cases, you support sustainability and the circular economy.

**Together, we can make a difference.
Join us in protecting both your gear and the planet.**



In addition to the fact that NANUK-R cases are designed for long-term use and recyclability, the shell of the NANUK-R Collection is made from a minimum of 95% post-consumer eco-friendly resin.

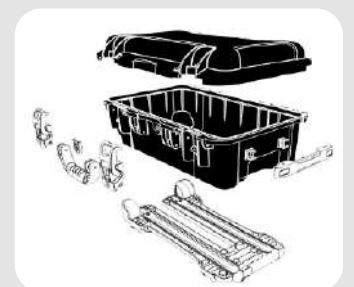

Configurations

5 DIFFERENT SETUPS

*Not available in all case sizes.

NANUK cases are designed for ultimate versatility, offering up to five different interior options to meet various organizational needs. Whether you're storing photo, video, or drone equipment

and accessories, NANUK provides tailored solutions for maximum protection and convenience. No matter your gear, NANUK ensures secure, organized, and easily accessible storage.

EMPTY

EM



CUBED FOAM FULL FOAM

CF
FF



COLLECTION FOAM

CUS



MESH LID ORGANIZER CUBIK 13L / HEAVY DUTY WHEELS

MC



PRO PHOTO KIT

PPK



LID ORGANIZER N-CUBIK

13/17



COLORS AVAILABLE

*Not available in all case sizes.

Be it for aesthetic preference or more practical purposes, color choice is an important feature for all NANUK users - choose from a pallet of 10.

Color options range from emergency orange to olive drab, meaning that you can blend in or stand out, whatever the task entails.

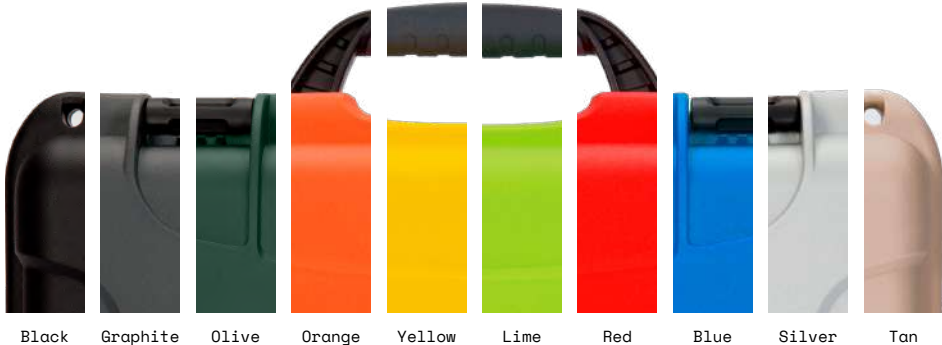

Black Graphite Olive Orange Yellow Lime Red Blue Silver Tan

*Possibility of custom colors with a minimum order..



Accessories

14 OPTIONS

*Not available in all case sizes.

NANUK offers up to 14 accessories, allowing users to customize, enhance, and adapt their setup as their needs evolve. From shoulder straps and lid organizers to TSA-approved padlocks and Molle System, these accessories provide

added convenience, security, and functionality. Whether upgrading for better organization or adapting to new gear, NANUK's wide range of accessories ensures a flexible and personalized storage solution for any shooting environment.



CUBED FOAM

Made of high quality polyurethane foam, the multilayered set of customizable inserts includes a prescored removable layer. This layer consists of foam to accommodate the contents of the case. This solution is ideal if you are seeking a quick and easy way to protect and organize your items.



FOAM INSERTS

Your gear, assets, and accessories receive the highest level of protection with custom-made protective foam designed for NANUK cases. The specially designed, high-quality closed-cell foam insert is pre-cut to fit your assets and accessories perfectly, providing maximum protection while keeping your most valuable items safe, sorted, and organized.



PADDED DIVIDERS

If you require compartmentalized protective organization of your components or equipment, our padded dividers are the right choice. Easily tailored to your needs with repositionable hook and loop fasteners, our padded dividers are designed to easily organize and protect your equipment.

Padded dividers available for selected models. Please refer to the features table of the specific model.



LID ORGANIZER

The NANUK Lid Organizer is the ideal organization and convenience accessory to add to your case. The molded interior is designed to help keep your hardware, power cords and accessories entirely organized and in-view. The lid organizer includes a set of mounting screws for easy, stress-free installation. Features include three zippered and anti-tear compartments of various sizes for lots of gear storage.

Lid organizer available for selected models. Please refer to the features table of the specific model.





N-CUBIK

N-CUBIK are designed for perfect alignment with other NANUK products or for standalone use. Seamlessly fitting into NANUK's hard cases and bags, they ensure smooth transitions. Experience effortless mobility for your essentials, ready for any adventure.

Fits 935 and 938



TECH POUCHES

Multiple pockets and internal dividers create a tidy and secure home to keep gear and accessories safe and within reach. Unique N-CUBIK organizers and tech pouches provide next level stand-alone organization and protection.



MESH LID ORGANIZER

The Mesh Lid Organizer is a practical and durable storage solution designed to maximize the space inside your NANUK case. Featuring multiple zippered compartments made from high-quality mesh, it enhances efficiency and keeps your accessories neatly arranged for any adventure or professional setup.

Fits 935 and 962 only

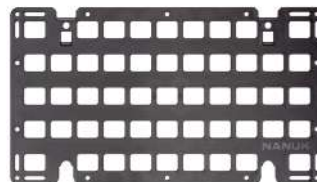

MOLLE SYSTEM

The NANUK MOLLE System is a versatile, modular storage solution for photographers who need easy access to their gear in dynamic environments. With this system, you can attach a variety of accessories, making it perfect for on-the-go shoots, outdoor photography, or travel.

Fits 935 and 962 only



ID WINDOW

Measuring 4" x 6", the polycarbonate identification plate allows you to identify the contents of the case, the shipping address or any other important information. Equipped with two hooks, the plate is compatible with NANUK models 962, 975, 976 and 988. It can only be added or removed with the case open.





AIRTAG HOLDER



The NANUK AirTag™ Holder is designed to securely hold an Apple AirTag (not included) in four different ways, offering versatile attachment options. This ultra-durable holder allows you to attach it to a wide range of items, such as Nanuk protective cases, backpacks, luggage, drones, cameras, keys, electronics, bikes, athletic equipment, or anything else you want to track. You can use it in the following ways: without a mount, with the mount using hook-and-loop adhesive, permanently mounted with 3M™ double-sided tape, or simply with the lanyard.

DESICCANT CONTAINERS



NANUK Reusable Desiccating Containers protect items from deterioration, rust, corrosion, mold, mildew, and other moisture-related damage. Simply place the Desiccating Container with the item in a sealed moisture-resistant container such as a Nanuk case. It will quickly remove moisture and maintain dryness to prevent damage, absorbing up to 34% of its weight in water vapor.

SHOULDER STRAP



Our neoprene shoulder strap incorporates Aircell™ comfort technology to reduce fatigue when transporting your case. The shoulder strap can easily be attached to most NANUK™ cases without any additional hardware.

Shoulder strap available for selected models. Please refer to the features table of the specific model.

TSA POWERCLAW LATCH RETROFIT KIT



We found a way to make our patented PowerClaw latches even better! They are now available with an integrated TSA accepted key lock. The easy to install retrofit kit can be installed on many NANUK cases and adds another layer of security to your case. Each lock has a special code TSA001 to TSA003, which is used by the TSA, CATSA and other security agencies to know which secure tool to use to open the lock. TSA accepted latches are the perfect accessory for storing, securing and protecting valuable items at home, on the job site and in your vehicle.

TSA PADLOCK



TSA padlocks offer the security of a padlock but can easily be opened and inspected by airport security and then locked again. A visual indicator lets you know when the lock has been opened with a TSA key.





ECO SYSTEM N-PVD

EXPLORING OUR BACKPACK LINE

NANUK is proud to present a collection of protection products that continue our tradition of pushing the boundaries to discover smarter and more elegant methods to protect, organize, and mobilize your gear.

GEAR ORGANIZATION ELEVATED

Unveil a world of effortless organization with our diverse range of bag sizes, N-CUBIK organizers, and Tech Pouches. Tailored for camera, video, and drone enthusiasts, our products transform chaos into clarity. Dive in and experience the ultimate harmony in gear arrangement.

FLEXIBILITY FOR ALL YOUR NEEDS

In the Nanuk Ecosystem, N-CUBIK are designed for perfect alignment. Seamlessly fitting into Nanuk's hard cases and bags, they ensure smooth transitions, be it from a hotel room to a jungle shoot. Experience effortless mobilization of your essentials, ready for every adventure.



SAFEGUARDED SERENITY FOR PROFESSIONALS

For photographers, videographers, and drone pilots, protection is paramount. Dive into our N-PVD packs and N-CUBIK ecosystem, where cutting-edge integration of recycled polyester fabrics meets robust internal and external padding. Our collection ensures your gear's safeguard against impacts and the unpredictability of nature, letting you focus on capturing the world's beauty undistracted.

UNPARALLELED PROTECTION

Our ecosystem of N-PVD packs, N-CUBIK organization and tech pouches offer superior impact and weather protection by integrating recycled polyester fabrics, internal padding and external EVA molded foam padding.

1. EVA compression molded foam bottoms so your gear doesn't fall over.
2. Double-layer foam padded body to protect your valuable gear.
3. YKK AquaGuard zippers for protection from the elements.
4. Removable rain cover protection for wet or dusty conditions.



**LIFETIME
WARRANTY**



**BLUESIGN®
APPROVED**
100% RECYCLED
POLYESTER FABRICS



**PFOA AND
PFC-FREE**
DURABLE WATER
REPELLENT FINISHES



**YKK®
AQUAGUARD®**
WATER-RESISTANT
ZIPPERS

CARRYING COMFORT



Padded and breathable contoured shoulder straps and waist belts.



Padded and breathable back panel.



PFOA AND PFC-FREE Durable water repellent finishes.

ENDLESS ORGANIZATION

Multiple pockets and internal dividers create a tidy and secure home to keep gear and accessories safe and within reach. Unique N-CUBIK organizers and tech pouches provide next level stand-alone organization and protection.

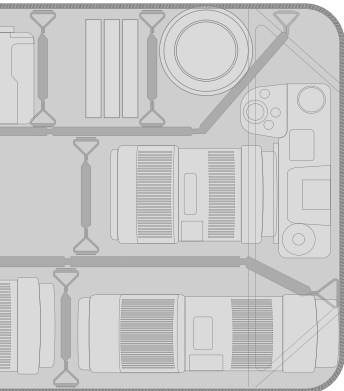

INTERNAL DIVIDER SYSTEMS

Removable and reconfigurable EVA compression molded dividers in our N-PVD packs and N-CUBIK organizers protect your valuable gear.

Using a unique TriBases shape, the internal organizers offer exceptional load shifting and impact resistance compared to conventional padded dividers.

Their tricot finish provides scratch-free protection.

Slotted faces and stretch elastic straps allow for smaller item stabilization.



MATERIALS AND FEATURES



Tripod Location
Built-in straps to carry your tripod



9 Hooks
Custom aluminum 9 hooks—solid connection and durable construction



Exterior Fabric
Bluesign certified recycled polyester fabrics BPA and PFOA free DWR coatings



N-PVD Ecosystem

ECOSYSTEM FUNCTIONALITY

NANUK's unique ecosystem of products provides unparalleled organization options. The N-CUBIK internal organizers and tech pouches seamlessly integrate with Nanuk's hard cases and backpacks for unmatched protection, organization and mobilization.



**Nanuk 935
+N-CUBIK 13S***
(sold separately)

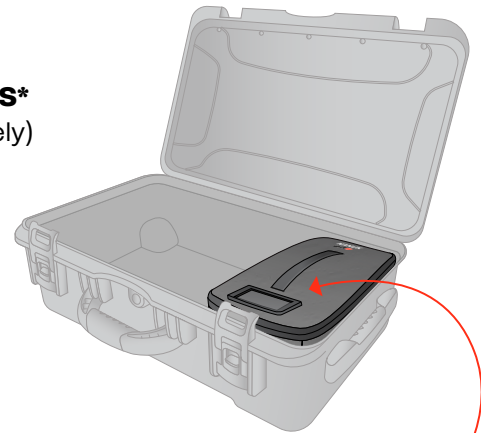

**N-PVD 35L
+N-CUBIK 13S***
(sold separately)

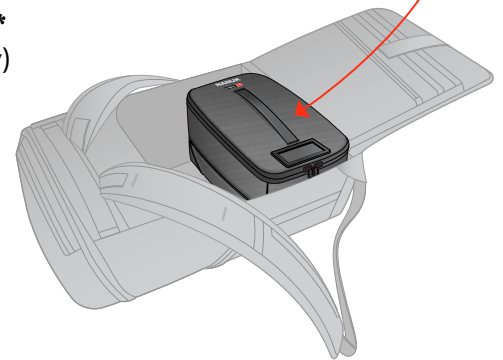

*N-CUBIK system fits in 935 and 938 Nanuk hard cases and N-PVD 30L, 35L and 40L models.

Create your own ecosystem in your image.

NANUK™

					Ecosystem functionality	
	29cm, 11.4in	30cm, 11.8in	31cm, 12.2in	30cm, 11.8in	56cm, 22in	61cm, 24in
13S	29cm, 11.4in	30cm, 11.8in	31cm, 12.2in	30cm, 11.8in	56cm, 22in	61cm, 24in
13M	29cm, 11.4in	30cm, 11.8in	31cm, 12.2in	30cm, 11.8in	56cm, 22in	61cm, 24in
13L	29cm, 11.4in	30cm, 11.8in	31cm, 12.2in	30cm, 11.8in	56cm, 22in	61cm, 24in
17S	29cm, 11.4in	30cm, 11.8in	31cm, 12.2in	30cm, 11.8in	56cm, 22in	61cm, 24in
17M	29cm, 11.4in	30cm, 11.8in	31cm, 12.2in	30cm, 11.8in	56cm, 22in	61cm, 24in
17L	29cm, 11.4in	30cm, 11.8in	31cm, 12.2in	30cm, 11.8in	56cm, 22in	61cm, 24in
		40L	35L	30L	935	938
		17S, 17M, 17L or 13S, 13M, 13L	17S, 17M or 13S, 13M	17S, 17M or 13S, 13M	13S, 13M, 13L	17S, 17M, 17L or 13S, 13M, 13L
		17L or 13L			13L	17L or 13L

N-PVD 15L Messenger



Int Dimension **17.7" × 13.8" × 6.3"**
(L x W x H) 45 × 35 × 16 cm

Weight **2.9 lb | 1.3 kg**
(Case Empty)

Volume **15 L**

Includes removable, reconfigurable, padded dividers.

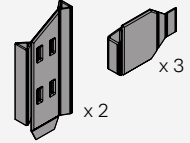

N-PVD 18L Backpack



Int Dimension **20.1" × 12.6" × 7.9"**
(L x W x H) 51 × 32 × 20 cm

Weight **3.0 lb | 1.4 kg**
(Case Empty)

Volume **18 L**

Includes removable, reconfigurable, padded dividers.

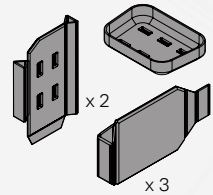

N-PVD 30L Backpack



Int Dimension **22.4" × 11.8" × 8.6"**
(L x W x H) 57 × 30 × 22 cm

Weight **4.4 lb | 2.0 kg**
(Case Empty)

Volume **30 L**

Includes removable, reconfigurable, padded dividers.

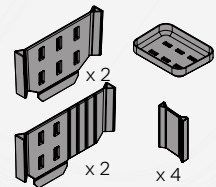



N-PVD 35L

Backpack



Int Dimension <i>(L x W x H)</i>	24.0" x 12.2" x 10.2" <i>61 x 31 x 26 cm</i>
Weight <i>(Case Empty)</i>	5.0 lb 2.3 kg
Volume	35 L

Includes removable, reconfigurable, padded dividers.

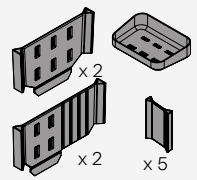

N-PVD 40L

Duffle Bag



Int Dimension <i>(L x W x H)</i>	22.8" x 11.8" x 8.2" <i>58 x 30 x 21 cm</i>
Weight <i>(Case Empty)</i>	4.9 lb 2.2 kg
Volume	40 L

1 N-Cubik collection sold separately



N-Cubik 13

13 Small



Int Dimension
(L x W x H)

6.2 x 11.4 x 5.0"
16 x 29 x 13 cm

13 Medium



Int Dimension
(L x W x H)

12.5 x 11.4 x 5.0"
32 x 29 x 13 cm

13 Large



Int Dimension
(L x W x H)

20.4 x 11.4 x 5.0"
52 x 29 x 13 cm

N-Cubik 17

17 Small



Int Dimension
(L x W x H)

7.0 x 11.4 x 6.6"
18 x 29 x 17 cm

17 Medium



Int Dimension
(L x W x H)

13.3 x 11.4 x 6.6"
34 x 29 x 17 cm

17 Large



Int Dimension
(L x W x H)

20.0 x 11.4 x 6.6"
51 x 29 x 17 cm

Tech Pouches

T1



Int Dimension
(L x W x H)

10 x 6.3 x 2.0"
25,5 x 16 x 5 cm

T2



Int Dimension
(L x W x H)

10.6 x 6,5 x 3.5"
27 x 16 x 9 cm

T3



Int Dimension
(L x W x H)

9.4 x 6.3 x 2.8"
24 x 16 x 7 cm



NANUK 935

Lid Organizer / N-Cubik 13

WHEELS



Int Dimension (L x W x H)	20.5" x 11.3" x 7.5" 521 x 287 x 191 mm
Ext Dimension (L x W x H)	22.0" x 14.0" x 9.0" 559 x 356 x 229 mm
Weight (Case Empty)	11.6 lb 5.3 kg
Volume	28.5 L

Configurations Available Colors

- 13L** ●
- 13M/S** ●

NANUK 938

Lid Organizer / N-Cubik 17

WHEELS



Int Dimension (L x W x H)	21.5" x 12.5" x 11.6" 546 x 318 x 294 mm
Ext Dimension (L x W x H)	23.8" x 15.5" x 13.2" 605 x 394 x 336 mm
Weight (Case Empty)	14.7 lb 6.7 kg
Volume	51.1 L

Configurations Available Colors

- 17L** ●
- 13M/S** ●

ECOSYSTEM N-PVD







CUSTOMISABLE GEAR PROTECTION

NANUK T20

Pro Photo/Video Kit



Int Dimension **10.8" x 7.1" x 9.0"**
(L x W x H) 274 x 180 x 229 mm

Ext Dimension **12.9" x 9.7" x 10.3"**
(L x W x H) 328 x 249 x 262 mm

Weight
(Case Empty) **3.8 lb | 1.7 kg**

Volume **11.2 L**

Configurations / Available Colors



NANUK T30

Pro Photo/Video Kit



Int Dimension **14.3" x 6.1" x 11.1"**
(L x W x H) 363 x 155 x 282 mm

Ext Dimension **16.5" x 9.3" x 12.5"**
(L x W x H) 419 x 236 x 305 mm

Weight
(Case Empty) **5.8 lb | 2.6 kg**

Volume **15.9 L**

Configurations / Available Colors

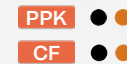

NANUK 904

Customisable Cubed Foam



Int Dimension **8.4" x 6.0" x 3.7"**
(L x W x H) 213 x 152 x 94 mm

Ext Dimension **10.2" x 7.9" x 4.5"**
(L x W x H) 259 x 201 x 114 mm

Weight
(Case Empty) **1.6 lb | 0.7 kg**

Volume **3.1 L**

Configuration / Available Color



NANUK 905

Pro Photo/Video Kit



Int Dimension **9.4" x 7.4" x 5.5"**
(L x W x H) 239 x 188 x 140 mm

Ext Dimension **12.5" x 10.1" x 6.0"**
(L x W x H) 318 x 257 x 152 mm

Weight
(Case Empty) **3.3 lb | 1.6 kg**

Volume **6.3 L**

Configurations / Available Color





CUSTOMISABLE GEAR PROTECTION

NANUK 908

Pro Photo/Video Kit



Int Dimension 9.5" x 7.5" x 7.5"
(L x W x H) 241 x 190 x 190 mm

Ext Dimension 12.5" x 9.8" x 8.0"
(L x W x H) 318 x 249 x 203 mm

Weight 3.6 lb | 1.6 kg
(Case Empty)

Volume 8.8 L

Configurations / Available Colors



NANUK 909

Customisable Cubed Foam



Int Dimension 11.4" x 7.0" x 3.7"
(L x W x H) 291 x 178 x 93 mm

Ext Dimension 12.6" x 9.0" x 4.4"
(L x W x H) 321 x 229 x 111 mm

Weight 2.2 lb | 1.0 kg
(Case Empty)

Volume 4.8 L

Configuration / Available Colors



NANUK 910

Customisable Cubed Foam



Int Dimension 13.2" x 9.2" x 4.1"
(L x W x H) 336 x 234 x 104 mm

Ext Dimension 14.3" x 11.1" x 4.7"
(L x W x H) 363 x 282 x 120 mm

Weight 3.0 lb | 1.4 kg
(Case Empty)

Volume 8.2 L

Configuration / Available Colors



NANUK 915

Pro Photo/Video Kit



Int Dimension 13.8" x 9.3" x 6.2"
(L x W x H) 351 x 236 x 157 mm

Ext Dimension 15.8" x 12.1" x 6.8"
(L x W x H) 401 x 307 x 173 mm

Weight 4.4 lb | 2.0 kg
(Case Empty)

Volume 13.0 L

Configurations / Available Colors



Configurations

PPK : Pro Photo Kit
CF : Cubed Foam

EM : Empty
CUS : Custom Foam

FF : Full Foam
PD : Padded Dividers

NANUK 918

Pro Photo/Video Kit



Int Dimension **14.9" x 9.8" x 8.6"**
(L x W x H) 378 x 249 x 218 mm

Ext Dimension **16.9" x 12.9" x 9.3"**
(L x W x H) 429 x 328 x 236 mm

Weight
(Case Empty) **6.4 lb | 2.9 kg**

Volume **20.6 L**

Configurations / Available Color

- PPK ●
- CF ●

NANUK 920

Pro Photo/Video Kit



Int Dimension **15.0" x 10.5" x 6.2"**
(L x W x H) 381 x 267 x 157 mm

Ext Dimension **16.7" x 13.4" x 6.8"**
(L x W x H) 424 x 340 x 173 mm

Weight
(Case Empty) **5.1 lb | 2.3 kg**

Volume **16.0 L**

Configurations / Available Colors

- PPK ●
- CF ●●

NANUK 923

Customisable Cubed Foam / TSA Latches



Int Dimension **16.7" x 11.3" x 5.4"**
(L x W x H) 422 x 287 x 137 mm

Ext Dimension **18.6" x 14.4" x 6.3"**
(L x W x H) 472 x 366 x 160 mm

Weight
(Case Empty) **6.0 lb | 2.7 kg**

Volume **16.7 L**

Configuration / Available Color

- CF ●

NANUK 923

Laptop Kit / TSA Latches



Int Dimension **16.7" x 11.3" x 5.4"**
(L x W x H) 422 x 287 x 137 mm

Ext Dimension **18.6" x 14.4" x 6.3"**
(L x W x H) 472 x 366 x 160 mm

Weight
(Case Empty) **6.0 lb | 2.7 kg**

Volume **16.7 L**

Configuration / Available Color

- LAP ●



NANUK 925

Pro Photo/Video Kit



Int Dimension **17.0" x 11.8" x 6.4"**
(L x W x H) 432 x 300 x 163 mm

Ext Dimension **18.7" x 14.8" x 7.0"**
(L x W x H) 475 x 376 x 178 mm

Weight
(Case Empty) **6.2 lb | 2.8 kg**

Volume **21.0 L**

Configurations / Available Colors



NANUK 930

Pro Photo/Video Kit



Int Dimension **18.0" x 13.0" x 6.9"**
(L x W x H) 457 x 330 x 175 mm

Ext Dimension **19.8" x 16.0" x 7.6"**
(L x W x H) 503 x 406 x 193 mm

Weight
(Case Empty) **7.1 lb | 3.2 kg**

Volume **26.5 L**

Configurations / Available Colors



CUSTOMISABLE GEAR PROTECTION

NANUK 933

Pro Photo/Video Kit



Int Dimension **18.0" x 13.0" x 9.5"**
(L x W x H) 457 x 330 x 241 mm

Ext Dimension **19.9" x 16.1" x 10.1"**
(L x W x H) 505 x 409 x 257 mm

Weight
(Case Empty) **8.0 lb | 3.6 kg**

Volume **36.4 L**

Configurations / Available Colors

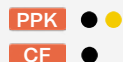

NANUK 935

Pro Photo/Video Kit



Int Dimension **20.5" x 11.3" x 7.5"**
(L x W x H) 521 x 287 x 191 mm

Ext Dimension **22.0" x 14.0" x 9.0"**
(L x W x H) 559 x 356 x 229 mm

Weight
(Case Empty) **11.6 lb | 5.3 kg**

Volume **28.5 L**

Configurations / Available Colors



Configurations

PPK : Pro Photo Kit
CF : Cubed Foam

EM : Empty
CUS : Custom Foam

FF : Full Foam
PD : Padded Dividers

NANUK 938

Pro Photo/Video Kit

WHEELS 



Int Dimension 21.5" x 12.5" x 11.6"
(L x W x H) 546 x 318 x 294 mm

Ext Dimension 23.8" x 15.5" x 13.2"
(L x W x H) 605 x 394 x 336 mm

Weight 14.7 lb | 6.7 kg
(Case Empty)

Volume 51.1 L

Configurations / Available Colors

- PPK ● ●
- CF ●
- EM ●

NANUK 940

Pro Photo/Video Kit



Int Dimension 20.0" x 14.0" x 8.0"
(L x W x H) 508 x 356 x 203 mm

Ext Dimension 21.7" x 16.9" x 8.5"
(L x W x H) 557 x 429 x 216 mm

Weight 8.4 lb | 3.8 kg
(Case Empty)

Volume 36.7 L

Configurations / Available Color

- PPK ●
- CF ●

NANUK 945

Pro Photo/Video Kit



Int Dimension 22.0" x 17.0" x 8.2"
(L x W x H) 559 x 432 x 208 mm

Ext Dimension 25.1" x 19.9" x 8.8"
(L x W x H) 638 x 505 x 224 mm

Weight 10.6 lb | 4.8 kg
(Case Empty)

Volume 50.2 L

Configurations / Available Colors

- PPK ● ●
- CF ● ●
- EM ●

NANUK 950

Pro Photo/Video Kit

WHEELS 



Int Dimension 20.5" x 15.3" x 10.1"
(L x W x H) 521 x 389 x 257 mm

Ext Dimension 22.8" x 18.3" x 11.7"
(L x W x H) 579 x 465 x 297 mm

Weight 15.1 lb | 6.8 kg
(Case Empty)

Volume 51.9 L

Configurations / Available Colors

- PPK ● ●
- PD ●
- CF ● ● ● ●
- EM ●

Configurations

NANUK 955

Pro Photo/Video Kit

WHEELS  



Int Dimension **22.0" x 17.0" x 10.2"**
(L x W x H) 559 x 432 x 259 mm

Ext Dimension **25.6" x 20.0" x 11.8"**
(L x W x H) 650 x 508 x 300 mm

Weight
(Case Empty) **18.4 lb | 8.3 kg**

Volume **62.5 L**

Configurations / Available Color

- PPK** ●
- PD** ●
- CF** ●
- EM** ●

NANUK 960

Pro Photo/Video Kit

WHEELS 



Int Dimension **22.0" x 17.0" x 12.9"**
(L x W x H) 559 x 432 x 328 mm

Ext Dimension **25.4" x 20.0" x 14.5"**
(L x W x H) 645 x 508 x 368 mm

Weight
(Case Empty) **19.2 lb | 8.7 kg**

Volume **79.0 L**

Configurations / Available Colors

- PPK** ●
- PD** ●
- CF** ● ●

PPK : Pro Photo Kit
CF : Cubed Foam

EM : Empty
CUS : Custom Foam

FF : Full Foam
PD : Padded Dividers



CUSTOMISABLE GEAR PROTECTION



NANUK 962

Pro Photo/Video Kit

WHEELS 



Int Dimension **28.0" x 16.5" x 9.3"**
(L x W x H) 711 x 419 x 236 mm

Ext Dimension **31.1" x 19.5" x 11.1"**
(L x W x H) 790 x 495 x 282 mm

Weight
(Case Empty) **21.2 lb | 9.6 kg**

Volume **70.6 L**

Configurations / Available Colors



NANUK 963

Pro Photo/Video Kit

WHEELS 



Int Dimension **29.0" x 18.1" x 10.5"**
(L x W x H) 737 x 460 x 267 mm

Ext Dimension **32.5" x 21.1" x 12.5"**
(L x W x H) 826 x 536 x 318 mm

Weight
(Case Empty) **22.5 lb | 10.2 kg**

Volume **90.7 L**

Configurations / Available Color



NANUK 965

Pro Photo/Video Kit

WHEELS 



Int Dimension **29.0" x 18.1" x 14.1"**
(L x W x H) 737 x 460 x 358 mm

Ext Dimension **32.5" x 21.1" x 15.9"**
(L x W x H) 826 x 536 x 404 mm

Weight
(Case Empty) **25.1 lb | 11.4 kg**

Volume **120 L**

Configurations / Available Color



NANUK 968

Padded Divider

WHEELS 



Int Dimension **21.5" x 21.5" x 11.8"**
(L x W x H) 546 x 546 x 300 mm

Ext Dimension **25.0" x 24.7" x 13.6"**
(L x W x H) 610 x 627 x 345 mm

Weight
(Case Empty) **21.6 lb | 9.8 kg**

Volume **89.4 L**

Configuration / Available Color



Configurations

PPK : Pro Photo Kit
CF : Cubed Foam

EM : Empty
CUS : Custom Foam

FF : Full Foam
PD : Padded Dividers



NANUK 970 Padded Divider

WHEELS



Int Dimension **24.0" x 24.0" x 14.2"**
(L x W x H) 610 x 610 x 361 mm

Ext Dimension **27.5" x 27.2" x 16.0"**
(L x W x H) 699 x 691 x 406 mm

Weight
(Case Empty) **26.5 lb | 12.0 kg**

Volume **134 L**

Configuration / Available Color

PD ●

NANUK 975 Pro Photo/Video Kit

WHEELS



Int Dimension **30.0" x 21.0" x 18.0"**
(L x W x H) 762 x 533 x 457 mm

Ext Dimension **33.5" x 24.3" x 19.7"**
(L x W x H) 851 x 617 x 500 mm

Weight
(Case Empty) **32.2 lb | 14.6 kg**

Volume **186 L**

Configurations / Available Color

PPK ●

PD ●

CF ●

CUSTOMISABLE GEAR PROTECTION



NANUK 976

Customisable Cubed Foam

WHEELS 



Int Dimension **31.0" x 26.0" x 15.8"**
(L x W x H) 787 x 660 x 400 mm

Ext Dimension **34.0" x 29.0" x 17.8"**
(L x W x H) 864 x 737 x 451 mm

Weight **36.6 lb | 16.6 kg**
(Case Empty)

Volume **208 L**

Configuration / Available Color

CF ●

NANUK 980

Pro Photo/Video Kit



Int Dimension **26.9" x 13.3" x 6.2"**
(L x W x H) 683 x 338 x 157 mm

Ext Dimension **29.9" x 16.2" x 7.3"**
(L x W x H) 760 x 412 x 186 mm

Weight **10.8 lb | 4.9 kg**
(Case Empty)

Volume **36.3 L**

Configurations / Available Colors

PPK ● ●

FF ● ●

NANUK 988

Padded Divider

WHEELS 



Int Dimension **41.8" x 13.6" x 12.5"**
(L x W x H) 1060 x 346 x 318 mm

Ext Dimension **44.9" x 16.3" x 13.6"**
(L x W x H) 1140 x 413 x 344 mm

Weight **24.0 lb | 10.9 kg**
(Case Empty)

Volume **117 L**

Configuration / Available Color

PD ●



LIFETIME WARRANTY



IP67 WATERPROOF



CRUSHPROOF RESIN



MILITARY APPROVED



MADE IN CANADA

Configurations

PPK : Pro Photo Kit
CF : Cubed Foam

EM : Empty
CUS : Custom Foam

FF : Full Foam
PD : Padded Dividers



CUSTOMISABLE GEAR PROTECTION



NANUK 915



COLLECTION FOAM - DRONE

NANUK 909

For DJI Mini 3 Pro



Int Dimension **11.4" x 7.0" x 3.7"**
(L x W x H) 291 x 178 x 93 mm

Ext Dimension **12.6" x 9.0" x 4.4"**
(L x W x H) 321 x 229 x 111 mm

Weight
(Case Empty) **2.2 lb | 1.0 kg**

Volume **4.8 L**

Configuration / Available Color



NANUK 915

For DJI Mini 4 Pro Fly More



Int Dimension **13.8" x 9.3" x 6.2"**
(L x W x H) 351 x 236 x 157 mm

Ext Dimension **15.8" x 12.1" x 6.8"**
(L x W x H) 401 x 307 x 173 mm

Weight
(Case Empty) **4.4 lb | 2.0 kg**

Volume **13.0 L**

Configuration / Available Colors



NANUK 920

For DJI Air 3S Fly More Combo



Int Dimension **15.0" x 10.5" x 6.2"**
(L x W x H) 381 x 267 x 157 mm

Ext Dimension **16.7" x 13.4" x 6.8"**
(L x W x H) 424 x 340 x 173 mm

Weight
(Case Empty) **5.1 lb | 2.3 kg**

Volume **16.0 L**

Configuration / Available Colors



NANUK 925

For DJI MAVIC 3



Int Dimension **17.0" x 11.8" x 6.4"**
(L x W x H) 432 x 300 x 163 mm

Ext Dimension **18.7" x 14.8" x 7.0"**
(L x W x H) 475 x 376 x 178 mm

Weight
(Case Empty) **6.2 lb | 2.8 kg**

Volume **21.0 L**

Configuration / Available Color





COLLECTION FOAM - DRONE



NANUK 925

For DJI MAVIC 3 pro



Int Dimension 17.0" x 11.8" x 6.4"
(L x W x H) 432 x 300 x 163 mm

Ext Dimension 18.7" x 14.8" x 7.0"
(L x W x H) 475 x 376 x 178 mm

Weight 6.2 lb | 2.8 kg
(Case Empty)

Volume 21.0 L

Configuration / Available Colors



NANUK 925

For DJI Avata 2 Fly More Combo



Int Dimension 17.0" x 11.8" x 6.4"
(L x W x H) 432 x 300 x 163 mm

Ext Dimension 18.7" x 14.8" x 7.0"
(L x W x H) 475 x 376 x 178 mm

Weight 6.2 lb | 2.8 kg
(Case Empty)

Volume 21.0 L

Configuration / Available Colors



NANUK 995

For RTK Matrice 300/P4

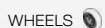

Int Dimension 52.0" x 14.5" x 6.0"
(L x W x H) 1321 x 368 x 152 mm

Ext Dimension 55.1" x 17.3" x 6.6"
(L x W x H) 1399 x 440 x 168 mm

Weight 21.6 lb | 9.8 kg
(Case Empty)

Volume 74.1 L

Configuration / Available Colors



LIFETIME WARRANTY



IP67 WATERPROOF



CRUSHPROOF RESIN



MILITARY APPROVED



MADE IN CANADA

Configurations

PPK : Pro Photo Kit
CF : Cubed Foam

EM : Empty
CUS : Custom Foam

FF : Full Foam
PD : Padded Dividers



COLLECTION FOAM - DRONE





COLLECTION - VIDEO

FOAM - VIDEO

NANUK 909

For Go pro hero 9



Int Dimension **11.4" x 7.0" x 3.7"**
(L x W x H) 291 x 178 x 93 mm

Ext Dimension **12.6" x 9.0" x 4.4"**
(L x W x H) 321 x 229 x 111 mm

Weight
(Case Empty) **2.2 lb | 1.0 kg**

Volume **4.8 L**

Configuration / Available Color

CUS ●

NANUK 909

For DJI Osmo Pocket 3



Int Dimension **11.4" x 7.0" x 3.7"**
(L x W x H) 291 x 178 x 93 mm

Ext Dimension **12.6" x 9.0" x 4.4"**
(L x W x H) 321 x 229 x 111 mm

Weight
(Case Empty) **2.2 lb | 1.0 kg**

Volume **4.8 L**

Configuration / Available Colors

CUS ● ● ● ● ●

NANUK 910

For Sennheiser ENG system/2 Senal system



Int Dimension **13.2" x 9.2" x 4.1"**
(L x W x H) 336 x 234 x 104 mm

Ext Dimension **14.3" x 11.1" x 4.7"**
(L x W x H) 363 x 282 x 120 mm

Weight
(Case Empty) **3.0 lb | 1.4 kg**

Volume **8.2 L**

Configuration / Available Color

CUS ●

NANUK 918

For 6 lens



Int Dimension **14.9" x 9.8" x 8.6"**
(L x W x H) 378 x 249 x 218 mm

Ext Dimension **16.9" x 12.9" x 9.3"**
(L x W x H) 429 x 328 x 236 mm

Weight
(Case Empty) **6.4 lb | 2.9 kg**

Volume **20.6 L**

Configuration / Available Colors

CUS ● ● ●

Configurations

PPK : Pro Photo Kit
CF : Cubed Foam

EM : Empty
CUS : Custom Foam

FF : Full Foam
PD : Padded Dividers



NANUK 920

For Ronin S4 Mini Combo Creator



Int Dimension 15.0" x 10.5" x 6.2"
(L x W x H) 381 x 267 x 157 mm

Ext Dimension 16.7" x 13.4" x 6.8"
(L x W x H) 424 x 340 x 173 mm

Weight 5.1 lb | 2.3 kg
(Case Empty)

Volume 16.0 L

Configuration / Available Colors



NANUK 930

For Ronin S4/S4 PRO Combo



Int Dimension 18.0" x 13.0" x 6.9"
(L x W x H) 457 x 330 x 175 mm

Ext Dimension 19.8" x 16.0" x 7.6"
(L x W x H) 503 x 406 x 193 mm

Weight 7.1 lb | 3.2 kg
(Case Empty)

Volume 26.5 L

Configuration / Available Colors



COLLECTION FOAM - PHOTO/VIDEO



NANUK 935

For 2 bodies DSLR

WHEELS  



Int Dimension **20.5" x 11.3" x 7.5"**
(L x W x H) 521 x 287 x 191 mm

Ext Dimension **22.0" x 14.0" x 9.0"**
(L x W x H) 559 x 356 x 229 mm

Weight **11.6 lb | 5.3 kg**
(Case Empty)

Volume **28.5 L**

Configuration / Available Color

CUS ●

NANUK 960

For Sony Burano

WHEELS 



Int Dimension **22.0" x 17.0" x 12.9"**
(L x W x H) 559 x 432 x 328 mm

Ext Dimension **25.4" x 20.0" x 14.5"**
(L x W x H) 645 x 508 x 368 mm

Weight **19.2 lb | 8.7 kg**
(Case Empty)

Volume **79.0 L**

Configuration / Available Colors

CUS ● ●





COLLECTION FOAM - PHOTO/VIDEO

Configurations

PPK : Pro Photo Kit
CF : Cubed Foam

EM : Empty
CUS : Custom Foam

FF : Full Foam
PD : Padded Dividers



NANUK® 925

NANUK® 925



ECO-FRIENDLY COLLECTION

NANUK 904



Int Dimension **8.4" x 6.0" x 3.7"**
(L x W x H) 213 x 152 x 94 mm

Ext Dimension **10.2" x 7.9" x 4.5"**
(L x W x H) 259 x 201 x 114 mm

Weight
(Case Empty) **1.6 lb | 0.7 kg**

Volume **3.1 L**

Configurations / Available Color

- CF** ●
- EM** ●

NANUK 909



Int Dimension **11.4" x 7.0" x 3.7"**
(L x W x H) 291 x 178 x 93 mm

Ext Dimension **12.6" x 9.0" x 4.4"**
(L x W x H) 321 x 229 x 111 mm

Weight
(Case Empty) **2.2 lb | 1.0 kg**

Volume **4.8 L**

Configurations / Available Color

- CF** ●
- EM** ●

NANUK 910



Int Dimension **13.2" x 9.2" x 4.1"**
(L x W x H) 336 x 234 x 104 mm

Ext Dimension **14.3" x 11.1" x 4.7"**
(L x W x H) 363 x 282 x 120 mm

Weight
(Case Empty) **3.0 lb | 1.4 kg**

Volume **8.2 L**

Configurations / Available Color

- CUS** ●
- EM** ●

NANUK 915



Int Dimension **13.8" x 9.3" x 6.2"**
(L x W x H) 351 x 236 x 157 mm

Ext Dimension **15.8" x 12.1" x 6.8"**
(L x W x H) 401 x 307 x 173 mm

Weight
(Case Empty) **4.4 lb | 2.0 kg**

Volume **13.0 L**

Configurations / Available Color

- PPK** ●
- CF** ●
- CF** ●

NANUK 920



Int Dimension **15.0" x 10.5" x 6.2"**
(L x W x H) 381 x 267 x 157 mm

Ext Dimension **16.7" x 13.4" x 6.8"**
(L x W x H) 424 x 340 x 173 mm

Weight **5.1 lb | 2.3 kg**
(Case Empty)

Volume **16.0 L**

Configurations / Available Color

- CF** ●
- EM** ●

NANUK 925



Int Dimension **17.0" x 11.8" x 6.4"**
(L x W x H) 432 x 300 x 163 mm

Ext Dimension **18.7" x 14.8" x 7.0"**
(L x W x H) 475 x 376 x 178 mm

Weight **6.2 lb | 2.8 kg**
(Case Empty)

Volume **21.0 L**

Configurations / Available Color

- PPK** ●
- CF** ●
- EM** ●

NANUK 935



Int Dimension **20.5" x 11.3" x 7.5"**
(L x W x H) 521 x 287 x 191 mm

Ext Dimension **22.0" x 14.0" x 9.0"**
(L x W x H) 559 x 356 x 229 mm

Weight **11.6 lb | 5.3 kg**
(Case Empty)

Volume **28.5 L**

Configurations / Available Color

- PPK** ●
- CF** ●
- CF** ●

NANUK 955



Int Dimension **22.0" x 17.0" x 10.2"**
(L x W x H) 559 x 432 x 259 mm

Ext Dimension **25.6" x 20.0" x 11.8"**
(L x W x H) 650 x 508 x 300 mm

Weight **18.4 lb | 8.3 kg**
(Case Empty)

Volume **62.5 L**

Configurations / Available Color

- CF** ●
- EM** ●

Configurations

PPK : Pro Photo Kit
CF : Cubed Foam







EM : Empty
CUS : Custom Foam

FF : Full Foam
PD : Padded Dividers





REFERENCE

	Interior dimensions	Exterior dimensions	Weight empty	Baggage	Retractable handle	Wheels
<i>Personal Utility Cases</i>						
225	L5.95" × W3.52" × H1.58" L151mm × W89mm × H40mm	L6.67" × W4.69" × H2.02" L169mm × W119mm × H51mm	0.45 lb 0.20 kg	Carry-on		
310	L5.2" × W3.0" × H1.1" L131mm × W77mm × H28mm	L5.9" × W4.3" × H1.7" L149mm × W110mm × H43mm	0.56 lb 0.26 kg	Carry-on		
320	L5.9" × W3.3" × H1.5" L151mm × W85mm × H39mm	L6.3" × W4.7" × H2.2" L161mm × W118mm × H55mm	0.77 lb 0.35 kg	Carry-on		
330	L6.7" × W3.8" × H1.9" L170mm × W96mm × H49mm	L7.4" × W5.1" × H2.6" L188mm × W130mm × H65mm	1.0 lb 0.45 kg	Carry-on		
<i>Small Cases</i>						
903	L7.4" × W4.9" × H3.1" L188mm × W124mm × H79mm	L9.1" × W6.8" × H3.8" L231mm × W173mm × H97mm	1.3 lb 0.6kg	Carry-on		
904 	L8.4" × W6.0" × H3.7" L213mm × W152mm × H94mm	L10.2" × W7.9" × H4.5" L259mm × W201mm × H114mm	1.6 lb 0.7 kg	Carry-on		
905	L9.4" × W7.4" × H5.5" L239mm × W188mm × H140mm	L12.5" × W10.1" × H6.0" L318mm × W257mm × H152mm	3.0 lb 1.4 kg	Carry-on		
908	L9.5" × W7.5" × H7.5" L241mm × W190mm × H190mm	L12.5" × W9.8" × H8.0" L318mm × W249mm × H203mm	3.6 lb 1.6 kg	Carry-on		
909 	L11.4" × W7.0" × H3.7" L291mm × W178mm × H93mm	L12.6" × W9.0" × H4.4" L321mm × W229mm × H111mm	2.1 lb 1.0 kg	Carry-on		
<i>Medium Cases</i>						
910 	L13.2" × W9.2" × H4.1" L336mm × W234mm × H104mm	L14.3" × W11.1" × H4.7" L363mm × W282mm × H120mm	3.0 lb 1.4 kg	Carry-on		
915 	L13.8" × W9.3" × H6.2" L351mm × W236mm × H157mm	L15.8" × W12.1" × H6.8" L401mm × W307mm × H173mm	4.4 lb 2.0 kg	Carry-on		
918	L14.9" × W9.8" × H8.6" L378 mm × W249 mm × H218 mm	L16.9" × W12.9" × H9.3" L429 mm × W328 mm × H236 mm	6.4 lb 2.9 kg	Carry-on		
920	L15.0" × W10.5" × H6.2" L381mm × W267mm × H157mm	L16.7" × W13.4" × H6.8" L424mm × W340mm × H173mm	5.1 lb 2.3 kg	Carry-on		
923	L16.7" × W11.3" × H5.4" L422 mm × W287 mm × H137 mm	L18.6" × W14.4" × H6.3" L472 mm × W366 mm × H160 mm	6.0 lb 2.7 kg	Carry-on		
925 	L17.0" × W11.8" × H6.4" L432mm × W300mm × H163mm	L18.7" × W14.8" × H7.0" L475mm × W376mm × H178mm	6.2 lb 2.8 kg	Carry-on		
930	L18.0" × W13.0" × H6.9" L457mm × W330mm × H175mm	L19.8" × W16.0" × H7.6" L503mm × W406mm × H193mm	7.1 lb 3.2 kg	Carry-on		
<i>Large Cases</i>						
933	L18.0" × W13.0" × H9.5" L457mm × W330mm × H241mm	L19.9" × W16.1" × H10.1" L505mm × W409mm × H257mm	8.0 lb 3.6 kg	Carry-on		
935 	L20.5" × W11.3" × H7.5" L521mm × W287mm × H191mm	L22.0" × W14.0" × H9.0" L559mm × W356mm × H229mm	11.6 lb 5.3 kg	Carry-on ¹	●	●
938	L21.5" × W12.5" × H11.6" L546mm × W318mm × H294mm	L23.8" × W15.5" × H13.2" L605mm × W394mm × H336mm	14.7 lb 6.7 kg	Checked	●	●
940	L20.0" × W14.0" × H8.0" L508mm × W356mm × H203mm	L21.7" × W16.9" × H8.5" L557mm × W429mm × H216mm	8.4 lb 3.8 kg	Checked		
945	L22.0" × W17.0" × H8.2" L559mm × W432mm × H208mm	L25.1" × W19.9" × H8.8" L638mm × W505mm × H224mm	10.6 lb 4.8 kg	Checked		
950	L20.5" × W15.3" × H10.1" L521mm × W389mm × H257mm	L22.8" × W18.3" × H11.7" L579mm × W465mm × H297mm	15.1 lb 6.8 kg	Checked	●	●
955 	L22.0" × W17.0" × H10.2" L559mm × W432mm × H259mm	L25.6" × W20.0" × H11.8" L650mm × W508mm × H300mm	18.2 lb 8.2 kg	Checked	●	●



Model cases are also available in recycled resin, black only.

¹ check with airline company



	Interior dimensions	Exterior dimensions	Weight empty	Baggage	Retractable handle	Wheels
960 	L22.0" × W17.0" × H12.9" L559mm × W432mm × H328mm	L25.4" × W20.0" × H14.5" L645mm × W508mm × H368mm	19.2 lb 8.7 kg	Checked	●	●
962	L28.0" × W16.5" × H9.3" L711mm × W419mm × H236mm	L31.1" × W19.5" × H11.1" L790mm × W495mm × H282mm	21.2 lb 9.62 kg	Oversized	●	●
963	L29.0" × W18.1" × H10.5" L737mm × W460mm × H267mm	L32.5" × W21.1" × H12.5" L826mm × W536mm × H318mm	22.5 lb 10.2 kg	Oversized	●	●
965	L29.0" × W18.1" × H14.1" L737mm × W460mm × H358mm	L32.5" × W21.1" × H15.9" L826mm × W536mm × H404mm	25.05 lb 11.36 kg	Oversized	●	●
968	L21.5" × W21.5" × H11.8" L546mm × W546mm × H300mm	L25.0" × W24.7" × H13.6" L610mm × W627mm × H345mm	21.6 lb 9.8 kg	Oversized	●	●
970	L24.0" × W24.0" × H14.2" L610mm × W610mm × H361mm	L27.5" × W27.2" × H16.0" L699mm × W691mm × H406mm	26.5 lb 12.0 kg	Oversized	●	●
975	L30.0" × W21.0" × H18.0" L762mm × W533mm × H457mm	L33.5" × W24.3" × H19.7" L851mm × W617mm × H500mm	32.2 lb 14.6 kg	Oversized	●	●
975W	L30.0" × W21.0" × H18.0" L762mm × W533mm × H457mm	L33.5" × W24.3" × H19.7" L851mm × W617mm × H500mm	30.6 lb 13.9 kg	Oversized	●	●
975T	L30.0" × W21.0" × H18.0" L762mm × W533mm × H457mm	L33.5" × W24.3" × H19.7" L851mm × W617mm × H500mm	28.5 lb 12.7 kg	Oversized	●	●
976	L31.0" × W26.0" × H15.8" L787mm × W660mm × H400mm	L34.0" × W29.0" × H17.8" L864mm × W737mm × H451mm	36.6 lb 16.6 kg	Oversized	●	●

Long Cases

980	L26.9" × W13.3" × H6.2" L683mm × W338mm × H157mm	L29.9" × W16.2" × H7.3" L760mm × W412mm × H186mm	10.8 lb 4.9 kg	Oversized		
985	L36.6" × W14.5" × H6.0" L930mm × W368mm × H152mm	L39.8" × W17.3" × H6.6" L1010mm × W440mm × H168mm	15.3 lb 6.9 kg	Oversized		●
988	L41.8" × W13.6" × H12.5" L1060mm × W346mm × H318mm	L44.9" × W16.3" × H13.6" L1140mm × W413mm × H344mm	24.0 lb 10.9 kg	Oversized		●
990	L44.0" × W14.5" × H6.0" L1118mm × W368mm × H152mm	L47.1" × W17.3" × H6.6" L1196mm × W440mm × H168mm	17.8 lb 8.1 kg	Oversized		●
991	L44.6" × W17.1" × H8.4" L1131mm × W435mm × H212mm	L47.8" × W20.1" × H9.5" L1212mm × W511mm × H241mm	24.0 lb 10.9 kg	Oversized		●
995	L52.0" × W14.5" × H6.0" L1321mm × W368mm × H152mm	L55.1" × W17.3" × H6.6" L1399mm × W440mm × H168mm	21.6 lb 9.8 kg	Oversized		●
996	L55.1" × W16.1" × H8.9" L1400mm × W409mm × H226mm	L58.4" × W18.9" × H10.0" L1482mm × W479mm × H254mm	28.0 lb 12.7 kg	Oversized		●

Top Loader Cases

T20	L10.8" × W7.1" × H9.0" L274mm × W180mm × H229mm	L12.9" × W9.7" × H10.3" L328mm × W249mm × H262mm	3.8 lb 1.7 kg			
T30	L14.3" × W6.1" × H11.1" L363mm × W155mm × H282mm	L16.5" × W9.3" × H12.5" L419mm × W236mm × H305mm	5.8 lb 2.6 kg			



Model cases are also available in recycled resin, black only.

¹check with airline company



Polyurethane Foam Insert	Lid Organizer	Padded Divider	Top Panel Kit	Bottom Panel Kit	TSA Power Claw Latch Retrofit Kit	Nanuk TSA Padlock	ID Window	Shoulder Strap	Air Tag Holder	Desiccant Container	Panel Mount Kit
●	●	●	●	●	●	●	●	●	●	●	●
●	●	●	●	●	●	●	●	●	●	●	●
●	●	●	●	●	●	●	●	●	●	●	●
●	●	●	●	●	●	●	●	●	●	●	●
●	●	●	●	●	●	●	●	●	●	●	●
●	●	●	●	●	●	●	●	●	●	●	●
●	●	●	●	●	●	●	●	●	●	●	●
●	●	●	●	●	●	●	●	●	●	●	●
●	●	●	●	●	●	●	●	●	●	●	●
●	●	●	●	●	●	●	●	●	●	●	●

●	●	●			●	●			●	●	●
●					●	IN			●	●	●
●	●	●			●	●			●	●	●
●					●	IN			●	●	●
●					●				●	●	●
●					●	IN			●	●	●
●					●		●		●	●	●

●	●	●				●		●	●	●	●
●	●	●			●	●		●	●	●	●

ACCESSORIES

Nanuk 962

Mesh Lid Organizer*



Molle System*



Top Loader Cases

Rigid Tray and Dividers



IN = Included



North America Headquarters

Nanuk Gear Protection Inc.
1059, Boulevard des Entreprises Ouest
Terrebonne (Québec) J6Y 1V2
CANADA
Tel.: 450 628.1006 | 1 800 783.6883
Email: info@nanuk.com
www.nanukcases.ca

NANUK Gear Protection USA inc.

2915, Ogletown Road
Newark, Delaware,
19713 USA
Tel.: 450 628.1006 | 1 800 783.6883
Email: info@nanuk.com
www.nanuk.com

NANUK EU B.V. NANUK Europe

Burg. J.G. Legroweg 96
9761 TD Eelde
The Netherlands
Tel: +31 50 3128694
Email: info@nanuk.eu
www.nanuk.eu