



1059, boulevard des Entreprises Ouest
 Terrebonne, QC Canada J6Y 1V2
 Tel 450-628-1006 1.800.783.6883
 Fax 450-628-7801 1.888.783.6883
 www.plasticase.com

ALU BEZEL PLATE TOP

PROJET_PROJECT

905-N_NANUK

PRODUIT_PRODUCT

905-N_ALUMINIUM BEZEL PLATE_TOP_a.00

DESSIN_DRAWING

STATUS

ALUMINIUM 1/8"

MATÉRIEL_MATERIAL

±.030" [±0.6mm]

TOLÉRANCE_TOLERANCE

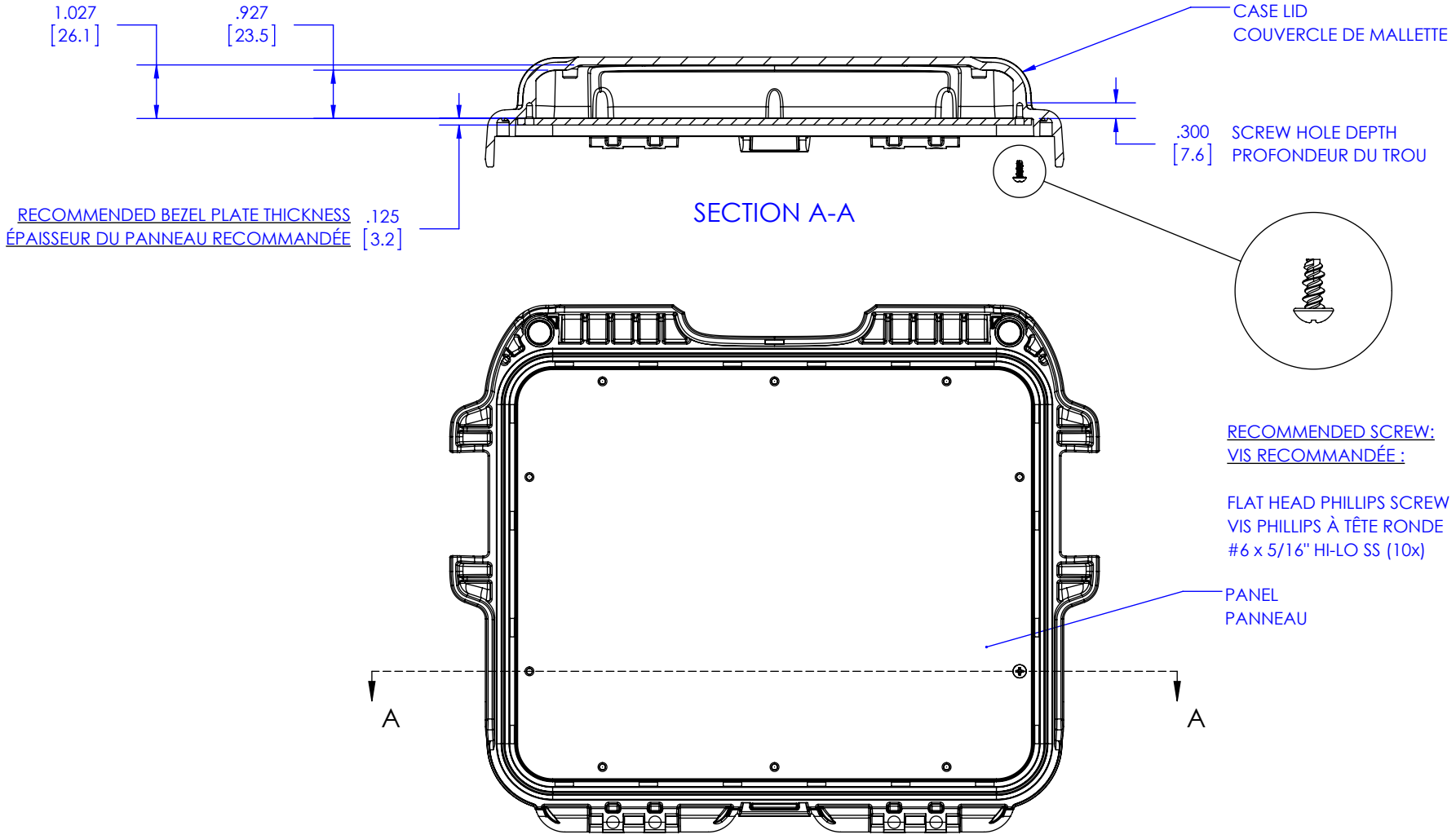

DIMENSIONS EN POUCE [MILLIMETRES] SAUF SI INDIQUÉ
 DIMENSIONS ARE IN INCHES [MILLIMETERS] UNLESS OTHERWISE SPECIFIED

L'INFORMATION CONTENUE DANS CE DESSIN EST LA PROPRIÉTÉ EXCLUSIVE DE PLASTICASE INC. TOUTE REPRODUCTION EN PARTIE OU COMPLÈTE N'EST PERMISESANS LE CONSENTEMENT ÉCRIT DE PLASTICASE INC. THE INFORMATION CONTAINED IN THIS DRAWING IS THE SOLE & EXCLUSIVE PROPERTY OF PLASTICASE INC. ANY REPRODUCTION IN PART OR WHOLE WITHOUT THE WRITTEN PERMISSION OF PLASTICASE INC. IS PROHIBITED.

ÉCHELLE_SCALE 1:3

Benjamin Coley
 REPRÉSENTANT_REPRESENTATIVE

Martin Keighan
 CONCEPTEUR_DESIGNER

2018-10-01
 DATE

1/2



1059, boulevard des Entreprises Ouest
 Terrebonne, QC Canada J6Y 1V2
 Tel 450-628-1006 1.800.783.6883
 Fax 450-628-7801 1.888.783.6883
 www.plasticase.com

ALU BEZEL PLATE TOP

PROJET_PROJECT

905-N_NANUK

PRODUIT_PRODUCT

905-N_ALUMINIUM BEZEL PLATE_TOP_a.00

DESSIN_DRAWING

STATUS

ALUMINIUM 1/8"

MATÉRIEL_MATERIAL

±.030" [±0.6mm]

TOLÉRANCE_TOLERANCE

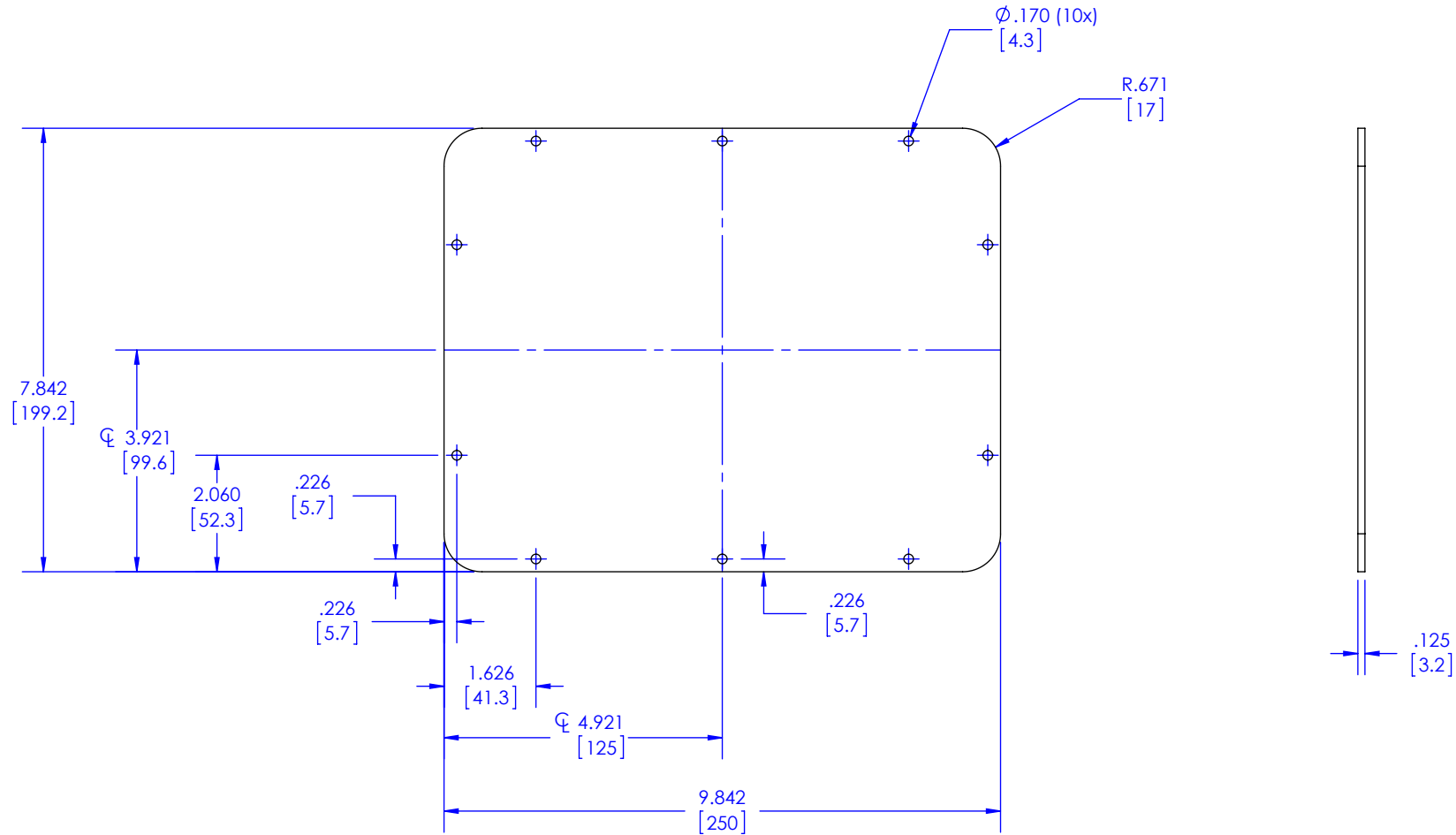

DIMENSIONS EN POUCE [MILLIMETRES] SAUF SI INDIQUÉ
 DIMENSIONS ARE IN INCHES [MILLIMETERS] UNLESS OTHERWISE SPECIFIED

L'INFORMATION CONTENUE DANS CE DESSIN EST LA PROPRIÉTÉ EXCLUSIVE DE PLASTICASE INC. TOUTE REPRODUCTION EN PARTIE OU COMPLÈTE N'EST PERMISE SANS LE CONSENTEMENT ÉCRIT DE PLASTICASE INC. THE INFORMATION CONTAINED IN THIS DRAWING IS THE SOLE & EXCLUSIVE PROPERTY OF PLASTICASE INC. ANY REPRODUCTION IN PART OR WHOLE WITHOUT THE WRITTEN PERMISSION OF PLASTICASE INC. IS PROHIBITED.

ÉCHELLE_SCALE 1:3

Benjamin Coley

REPÉSENTANT_REPRESENTATIVE

Martin Keighan

CONCEPTEUR_DESIGNER

2018-10-01

DATE

2/2